

IR4053 IR4053-10

IR4055 IR4055-11

IR4056 IR4056-20
IR4056-21

IR4057-50

HIOKI

Instruction Manual

INSULATION TESTER



EN

May 2021 Revised edition 1
IR4057B961-01 21-05H
(IR4052C960-01)



* 6 0 0 6 1 3 9 1 1 *

Model-specific functionality

The following functionality is available on a model-specific basis:

✓: Supported –: Not supported

| Functionality | Models (As shown on instrument) | | | | See |
|---|------------------------------------|--------|--------|-----------|-------|
| | IR4053 | IR4055 | IR4056 | IR4057-50 | |
| Displaying 1-minute Values | – | – | – | ✓ | p. 37 |
| Negative Voltage Notification | ✓ | ✓ | – | – | p. 40 |
| Low Resistance Measurement | – | – | ✓ | ✓ | p. 42 |
| PVΩ Measurement | ✓ | ✓ | – | – | p. 44 |
| Wireless Communications (GENNECT Cross) | – | ✓ | – | ✓* | p. 51 |
| Wireless Communications (HID function) | – | – | – | ✓* | p. 55 |

*: Z3210 Wireless Adapter (option) required.

Contents

| | |
|----------------------------------|---|
| Introduction..... | 1 |
| Verifying Package Contents | 1 |
| Notations | 4 |
| Safety Information | 7 |
| Operating Precautions | 9 |

1 Overview 13

| | |
|--|----|
| 1.1 Product Overview..... | 13 |
| 1.2 Names and Functions of Parts | 14 |

2 Preparing for Measurement 21

| | |
|--|----|
| 2.1 Replacing Batteries or Fuse..... | 22 |
| 2.2 Using the L9788-10 Test Lead with Remote Switch (Red) | 25 |
| 2.3 Installing the Z3210 Wireless Adapter (IR4057-50 only)..... | 27 |

3 Measurement 29

| | |
|---|----|
| 3.1 Pre-measurement Inspection..... | 29 |
| 3.2 Auto Power Save (Power-Saving Function)30 | |
| 3.3 Auto Backlight-off (Automatic Light-off Function)..... | 30 |
| 3.4 Comparator Function..... | 31 |
| Setting the Comparator..... | 32 |
| Canceling the Comparator..... | 33 |
| 3.5 Insulation Resistance Measurement..... | 34 |
| Lock Function | 35 |
| Measuring Insulation Resistance..... | 36 |
| Displaying 1-minute Values (IR4057-50 only)..... | 37 |
| Voltage Characteristics of Measurement Terminals.. | 38 |

1

2

3

4

5

Appx.

| | | |
|-----------------|--|---------------|
| 3.6 | Discharging Function | 39 |
| 3.7 | Voltage Measurement | 40 |
| | Negative Voltage Notification Function (IR4053 and IR4055 only)..... | 41 |
| 3.8 | Low Resistance Measurement (IR4056 and IR4057-50 only)..... | 42 |
| 3.9 | PVΩ Measurement Function (IR4053 and IR4055 only)..... | 44 |
| 3.10 | Wireless Communications Function | 51 |
| | Using the GENNECT Cross (IR4055 and IR4057-50 only) | 51 |
| | Excel® Direct Input Function (HID function) (IR4057-50 only)..... | 55 |
| 4 | Specifications | 59 |
| 4.1 | General Specifications | 59 |
| 4.2 | Basic and Accuracy Specifications..... | 61 |
| 4.3 | Functionality specifications..... | 69 |
| | Power-on Options | 70 |
| 5 | Maintenance and Service | 71 |
| 5.1 | Troubleshooting | 72 |
| | Errors and status codes | 77 |
| Appendix | Appx.1 | |
| | Appx. 1 Measurement Principles | Appx.1 |
| | Appx. 2 Operation Uncertainty | Appx.2 |
| | Appx. 3 Insulation Resistance Measurements for Solar Cell Array | Appx.3 |

Introduction

Thank you for choosing the Hioki IR4053-10, IR4055-11, IR4056-20, IR4056-21, and IR4057-50 Insulation Tester. To ensure your ability to get the most out of this instrument over the long term, please read this manual carefully and keep it available for future reference. Hereinafter, the descriptions refer to models as shown on the instrument.

Verifying Package Contents

When you receive the instrument, inspect it carefully to ensure that no damage occurred during shipping. In particular, check the accessories, panel switches, and connectors. If damage is evident, or if it fails to operate according to the specifications, contact your authorized Hioki distributor or reseller. Confirm that these contents are provided.

- Insulation Tester

IR4053, IR4055
IR4056



IR4057-50



- Instruction Manual
- Operating Precautions (0990A907)
- LR6 Alkaline battery × 4
- Neck strap

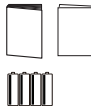

- L9787 Test Lead (IR4053-10 and IR4056-20 only)



- L9788-11 Test Lead Set with Remote Switch (IR4055-11 and IR4056-21 only)



- L4930 Connection Cable Set (IR4057-50 only)



- L4935 Alligator Clip Set (IR4057-50 only)



- L4938 Test Pin Set (IR4057-50 only)



Options

The options listed below are available for the instrument. To order an option, please contact your authorized Hioki distributor or reseller.

Options are subject to change. Please check Hioki's website for the latest information.

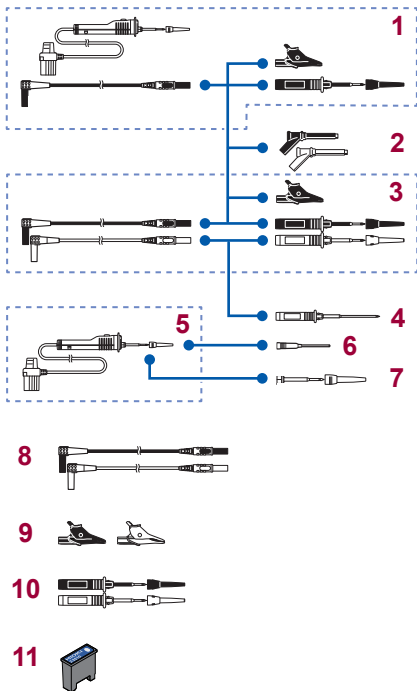







| | Model | Maximum rated voltage and maximum rated current |
|-----------|--|---|
| 1 | L9788-11 Test Lead Set with Remote Switch | CAT III 600 V/CAT II 600 V, 2 A |
| 2 | 9804-01 Magnet Adapter (Red) 9804-02 Magnet Adapter (Black) (ϕ 11 mm, standard screw: M6 pan head screw) | CAT IV 1000 V, 2 A |
| 3 | L9787 Test Lead (1.2 m) | CAT III 600 V/CAT II 600 V, 10 A |
| 4 | L9787-91 Breaker Pin | CAT III 600 V, 10 A |
| 5 | L9788-10 Test Lead with Remote Switch (Red) | CAT III 600 V/CAT II 600 V, 2 A |
| 6 | L9788-92 Breaker Pin | CAT III 600 V, 2 A |
| 7 | L9788-90 Tip Pin | CAT III 600 V/CAT II 600 V, 2 A |
| 8 | L4930 Connection Cable Set (1.2 m) | CAT IV 600 V/CAT III 1000 V, 10 A |
| 9 | L4935 Alligator Clip Set | CAT IV 600 V/CAT III 1000 V, 10 A |
| 10 | L4938 Test Pin Set | CAT III 600 V/CAT II 600 V, 10 A |
| 11 | Z3210 Wireless Adapter (for IR4057-50) | – |









Notations

Safety notations



In this document, the severity levels of risk and hazard are classified as follows.

| | |
|--|--|
|  DANGER | Indicates an imminently hazardous situation that will result in death or serious injury to the operator. |
|  WARNING | Indicates a potentially hazardous situation that may result in death or serious injury to the operator. |
|  CAUTION | Indicates a potentially hazardous situation that may result in minor or moderate injury to the operator or damage to the instrument or malfunction. |
| IMPORTANT | Indicates information or content that is particularly important from the standpoint of operating or maintaining the instrument. |
|  | Indicates a strong magnetic-field hazard. The effects of the magnetic force can cause abnormal operation of heart pacemakers and/or medical electronics. |
|  | Indicates prohibited actions. |
|  | Indicates the action which must be performed. |
| * | Additional information is presented below. |

Symbols on the instrument

| | |
|--|--|
|  <p>Indicates cautions and hazards. When the symbol is printed on the instrument, refer to a corresponding topic in the Instruction Manual.</p> |  <p>Indicates a grounding terminal.</p> |
|  <p>Indicates that dangerous voltage may be present at this terminal.</p> |  <p>Indicates DC (Direct Current).</p> |
|  <p>Indicates an instrument that has been protected throughout by double insulation or reinforced insulation.</p> |  <p>Indicates AC (Alternating Current).</p>   <p>Do not use in distribution systems with voltage higher than 660 V AC.</p> |

Symbols for various standards

| | |
|---|--|
|  | <p>Indicates the Waste Electrical and Electronic Equipment Directive (WEEE Directive) in EU member states.</p> |
|  | <p>Indicates that the product conforms to regulations set out by the EU Directive.</p> |

Screen Display

The instrument screen displays the alphanumeric characters as follows.

| | | | | | | | | | | | | | | | | | | | | | | | | | |
|---|---|---|---|---|---|---|---|---|---|---|---|---|---|---|---|---|---|---|---|---|---|---|---|---|---|
| A | B | C | D | E | F | G | H | I | J | K | L | M | N | O | P | Q | R | S | T | U | V | W | X | Y | Z |
| R | b | c | d | E | F | G | H | . | u | l | n | o | p | q | r | s | t | u | v | w | x | y | z | ≡ | |

| | | | | | | | | | |
|---|---|---|---|---|---|---|---|---|---|
| 1 | 2 | 3 | 4 | 5 | 6 | 7 | 8 | 9 | 0 |
| 1 | 2 | 3 | 4 | 5 | 6 | 7 | 8 | 9 | 0 |

Accuracy

Hioki expresses accuracy as error limit values specified in terms of percentages of reading and digits.

| | |
|--------------------------------------|---|
| Reading (Displayed value) | Refers to the displayed value of the measuring instrument. The limit values of reading errors are expressed in percent of reading (% of reading, % rdg). |
| Digits (Resolution) | Refers to the smallest change in the indication on the digital measuring instrument, i.e., the numeral one in the rightmost place. The limit values of digit errors are expressed in terms of digits (dgt). |

Trademarks

- The Bluetooth[®] word mark and logos are registered trademarks owned by Bluetooth SIG, Inc. and any use of such marks by Hioki E.E. Corporation is under license.
Other trademarks and trade names are those of their respective owners.
- Microsoft Excel is either registered trademarks or trademarks of Microsoft Corporation in the United States and other countries.

Safety Information

This instrument is designed to conform to IEC 61010 Safety Standards, and has been thoroughly tested for safety prior to shipment. However, using the instrument in a way not described in this manual may negate the provided safety features.

Before using the instrument, be certain to carefully read the following safety notes:

DANGER



Mishandling during use could result in injury or death, as well as damage to the instrument. Be certain that you understand the instructions and precautions in the manual before use.

WARNING



Protective gear
Performing measurement using this instrument involves live-line work. To prevent an electric shock, use appropriate protective insulation and adhere to applicable laws and regulations.

Measurement Categories

To ensure safe operation of measuring instruments, IEC 61010 establishes safety standards for various electrical environments, categorized as CAT II to CAT IV, and called measurement categories.

DANGER



- **Using a measuring instrument in an environment designated with a higher-numbered category than that for which the instrument is rated could result in a severe accident, and must be carefully avoided.**
- **Never use a measuring instrument that lacks category labeling in a CAT II to CAT IV measurement environment. Doing so could result in a serious accident.**

This instrument conforms to the safety requirements for CAT III 600 V measuring instruments.

- CAT II: When directly measuring the electrical outlet receptacles of the primary electrical circuits in equipment connected to an AC electrical outlet by a power cord (portable tools, household appliances, etc.)
- CAT III: When measuring the primary electrical circuits of heavy equipment (fixed installations) connected directly to the distribution panel, and feeders from the distribution panel to outlets.
- CAT IV: When measuring the circuit from the service drop to the service entrance, and to the power meter and primary overcurrent protection device (distribution panel).

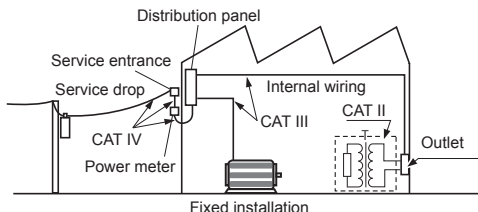

Operating Precautions

Observe the following precautionary information to ensure that the instrument can be used safely and in a manner that allows it to perform as described in its specifications.

Use of the instrument should confirm not only to its specifications, but also to the specifications of all accessories, options, batteries, and other equipment in use.

DANGER



- **For your safe operation, do not connect any test lead to the primary of the distribution panel.**
- **Do not short-circuit two wires to be measured by bringing the test leads into contact with them. Arcs or such grave accidents are likely to occur.**
- **To avoid short circuit or electric shock, do not touch the metal part of the connecting test lead tip.**
- **To avoid electric shock, be careful to avoid shorting live lines with the test leads tip.**

If the test lead or the instrument is damaged, there is a risk of electric shock. Perform the following inspection before using them:



- **Before using the instrument check that the coating of the test leads are neither ripped nor torn and that no metal parts are exposed. Using the instrument under such conditions could result in electric shock. Replace the test leads with those specified by Hioki.**
 - **Verify that the instrument operates normally to ensure that no damage occurred during storage or shipping. If you find any damage, contact your authorized Hioki distributor or reseller.**
-

WARNING

To avoid electric shock, short circuits and damage to the instrument, observe the following precautions:



- Check the position of the rotary switch before taking measurements.
- Disconnect the test leads from the measuring object before switching the rotary switch.



- Do not use the instrument with circuits that exceed its ratings or specifications. Doing so may damage the instrument, resulting in electric shock.



- Use only the specified test leads. Use of any test lead not specified by Hioki does not allow safe measurements.
- To prevent electrical accidents, turn off the circuit before connecting the test leads.
- To avoid electric shock, do not exceed the lower of the ratings shown on the instrument and test leads.

CAUTION



- The cable is hardened under the 0°C or colder environment. Do not bend or pull it to avoid tearing its shield or cutting cable.
- The protection rating for the enclosure of this device (based on EN 60529) is IP40*.

* IP40:

This indicates the degree of protection provided by the enclosure of the device against use in hazardous locations, entry of solid foreign objects, and the ingress of water.

- 4: Protected against access to hazardous parts with wire measuring 1.0 mm in diameter.
- 0: The equipment inside the enclosure is not protected against the harmful effects of water.

Installing the instrument

WARNING

Installing the instrument in inappropriate locations may cause a malfunction of instrument or may give rise to an accident. Avoid the following locations.



- Exposed to direct sunlight or high temperature
- Exposed to corrosive or combustible gases
- Exposed to a strong electromagnetic field or electrostatic charge
- Near induction heating systems (such as high-frequency induction heating systems and IH cooking equipment)
- Susceptible to vibration
- Exposed to water, oil, chemicals, or solvents
- Exposed to high humidity or condensation
- Exposed to high quantities of dust particles

CAUTION



Do not place the instrument on an unstable table or an inclined place. Dropping or knocking down the instrument can cause injury or damage to the instrument.

Precautions when transporting the instrument

During shipment of the instrument, handle it carefully so that it is not damaged due to a vibration or shock.

Handling the Instrument

DANGER



Persons wearing electronic medical devices such as a pacemaker should not use the 9804-01, 9804-02 Magnet Adapter. Such persons should avoid even proximity to the 9804-01 and 9804-02, as it may be dangerous. Medical device operation could be compromised, presenting a hazard to human life.

CAUTION



To avoid damage to the instrument, protect it from physical shock when transporting and handling. Be especially careful to avoid physical shock from dropping.

Test leads

CAUTION



- Removable sleeves are attached to the metal pins at the end of the test leads. To prevent a short circuit accident, be sure to use the test leads with the sleeves attached when performing measurements in the CAT III measurement category. Remove the sleeves before starting CAT II measurements. You can use the test leads with the sleeve removed for secondary side of the circuit breakers turned off. (See “Measurement Categories” (p. 8))
- If the sleeves are inadvertently removed during measurement, stop the measurement. (p.26)

1.1 Product Overview

This instrument is an insulation ohmmeter that shortens work times associated with insulation testing. It is not designed for use on manufacturing lines and should not be used in such applications. For manufacturing line applications, use the ST5520 Insulation Tester.

High-speed response

- Considerably improved response time compared to previous models.
- The instrument can be used like models with a meter needle.

Enhanced comparator function

- Can be used similarly to the continuity check with a tester due to judgment after the start of measurement being extremely short.
- The backlight lights up in red for a FAIL judgment (defective).

Low variation in measured values

- The instrument generates little variation in measured values when used in a typical measuring environment.

Easy-to-view display

- Backlight source is a white high-intensity LED.
- Wide viewing angle LCD

High-accuracy voltage measurement function

- The instrument incorporates a DC/AC voltmeter with the same accuracy as a card tester.
- There is no need to switch to a card tester when you need to measure voltage.

PVΩ measurement function (IR4053 and IR4055 only)

- Insulation resistance can be measured accurately for solar battery panel.

1.2 Names and Functions of Parts

Front

IR4056, IR4057-50 (The illustration shows the IR4057-50)

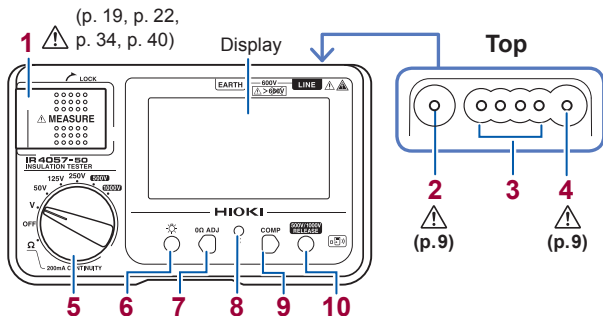

- | | |
|---------------------------------|--|
| 1 MEASURE key (p.16) | Starts insulation resistance measurement. |
| 2 EARTH terminal | Connects the black test lead. |
| 3 CONTROL terminal | Controls L9788-10 Test Lead with Remote Switch (Red) |
| 4 LINE terminal | Connects the red test lead. |
| 5 Rotary switch | Selects measurement functions. |
| 6 LIGHT key | Turns on and off the backlight. |
| 7 0Ω ADJ key | Performs zero-adjustment for the low resistance range. Press with the COMP key simultaneously: configures the wireless communications function (p. 51) (IR4057-50) |
| 8 Live circuit indicator | Lights up when voltage remains between input terminals. |

9 COMP key

Sets the comparator's judgment reference value.

Press with the **0Ω ADJ** key simultaneously: configures the wireless communications function. (p. 51) (IR4057-50)

10 RELEASE key

Press before measurement to set the instrument to the 500 V or 1000 V range (to prevent erroneous application of the test signal).

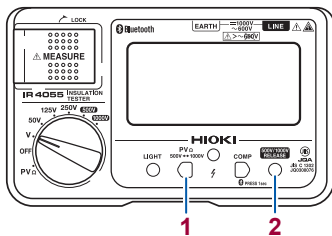
IR4053, IR4055 (The illustration shows the IR4055)

(Other functions are the same as IR4056 and IR4057-50.)

1 500 V ↔ 1000 V key

Switches between 500 V and 1000 V when using PVΩ range.

2 COMP key (1 s)

Configures wireless communications function (p. 51) (IR4055)

3 500 V/1000 V RELEASE key

- Press before measurement to set the instrument to the 500 V or 1000 V range (to prevent erroneous application of the test signal).
- Applied voltage is confirmed when PVΩ range is set.

MEASURE key

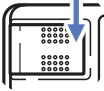
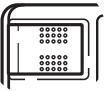
| | | | |
|------------------------------|---|---|---|
| MEASURE key operation |  |  |  |
| | Pull* | Press and hold right side | Fold down (or release). |
| Description in this manual | Turn on the MEASURE key. | | Turn off the MEASURE key. |

*: Convenient way for performing measurement repeatedly

Power OFF

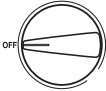

| | |
|-----------------------------|---|
| Rotary switch status |  |
| Description in this manual | Turn off the rotary switch. |

Display

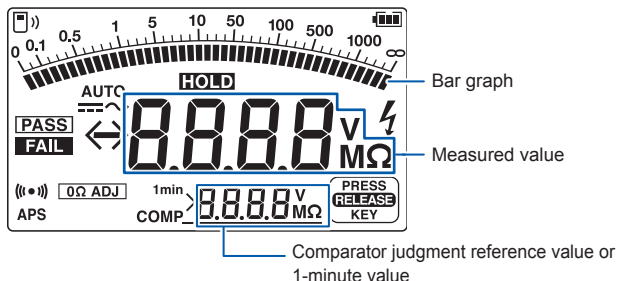
IR4057-50



| | |
|---------------|--|
| | Battery indicator (three levels) (p.29) |
| | Turns on when the voltage measured with the V range is DC. |
| | Turns on when the voltage measured with the V range is AC. |
| | Blinks when the measured value is less than the minimum display value. |
| | Blinks when the measured value is greater than the maximum display value. |
| HOLD | Turns on when the measured value is retained. |
| PASS | Turns on when the comparator judgment is PASS (good). (p.31) |
| FAIL | Turns on when the comparator judgment is FAIL (defective). (p.31) |
| | Blinks when a dangerous voltage exists between the measurement terminals. |
| | Judgment result buzzer (only when comparator is set) (p.31) |
| APS | Appears 30 s before auto power save function is activated. (p.30) |
| 0Ω ADJ | Turns on when zero adjustment is performed during low resistance measurement. (p.42) |

| | |
|---|--|
| 1min | <p>Displaying 1-minute values (p.37)</p> <ul style="list-style-type: none"> • Turns on when 1 minute has passed since the start of insulation resistance measurement. • Indicates that the resistance value on the bottom of the display is a 1-minute value (the measured value 1 minute after the start of measurement). |
| COMP | <p>Turns on when the comparator function is enabled. (p.31)</p> <p>Turns on when the instrument is set to the 500 V range or the 1000 V range.</p> |
|  | <p>Pressing  turns off the indicator and enables insulation measurement.</p> |
|  | <p>Indicates wireless communications function status. (p. 51)</p> |

IR4056

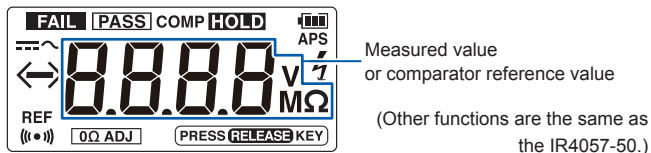

| | |
|------------|---|
| REF | <p>Turns on when the reference value is indicated by the comparator function.</p> |
|------------|---|

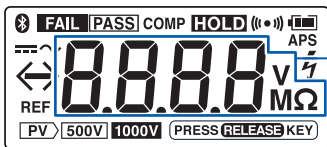
IR4053, IR4055 (The illustration shows the IR4055)

Measured value
or comparator reference value

(Other functions are the same as the
IR4056 and the IR4057-50.)



Turns on when the PVΩ measurement mode is selected.



Turns on when selecting 500 V range in the PVΩ measurement mode.



Turns on when selecting 1000 V range in the PVΩ measurement mode.



Indicates wireless communications function status. (p. 51)
(IR4055)

REAR (Serial number label)

The serial number consists of nine digits. The first two indicate the year of manufacture (the last two digits of the Western year), and the next two indicate the month of manufacture.

L9788-10 Test Lead with Remote Switch (Red)

CAUTION



The **MEASURE** key of the instrument is enabled even when the L9788-10 is connected to an insulation resistance tester. Note that the testing voltage is output when the **MEASURE** key of the instrument is turned ON while the L9788-10 is connected.

Refer to “Attaching the L9788-92 Breaker Pin” (p. 26)

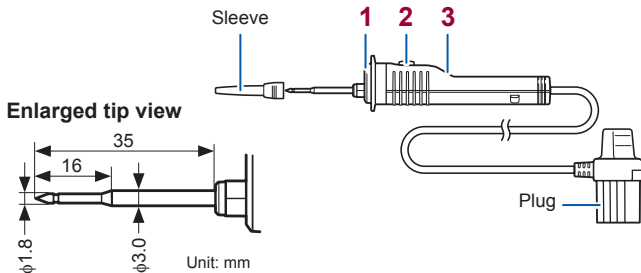

1 Light

Lights up interlocked with the backlight of the instrument.

2 **MEASURE** key

- Starts insulation resistance measurement.
- Lights up in red interlocked with the live wire warning indicator of the instrument.

3 Judgment display

Lights up in accordance with the comparator judgment result.

- PASS: Green
- FAIL: Red

2

Preparing for Measurement

⚠ CAUTION



Attach the strap securely to the four fittings on the instrument. If insecurely attached, the instrument may fall and be damaged when carrying.

1 Attach the strap.

Slightly extend each of the four double-loop split rings and pass the ring through a lug-hole on the instrument.

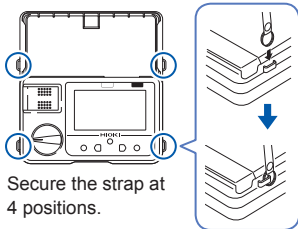

2 Insert the batteries. (p.22)

3 Connect the test leads to the terminals.

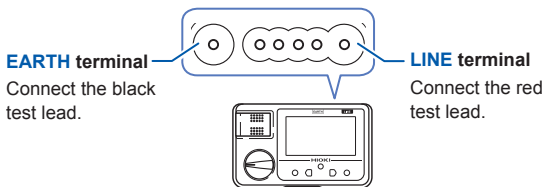

4 Attach each test pin or alligator clip to a lead.

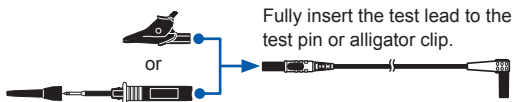

2.1 Replacing Batteries or Fuse

WARNING



- To avoid electric shock, turn off the **MEASURE** key, disconnect the test leads from the measuring object before replacing the battery cover.



- After replacing the batteries, reattach the cover and secure the screw before using the instrument.
- Battery may explode if mistreated. Do not shortcircuit, recharge, disassemble or dispose of in fire.
- Replace the fuse only with one of the specified type, characteristics, rated current, and rated voltage. Do not use fuses other than those specified (especially, do not use a fuse with higher-rated current) or do not short circuit and use the fuse holder. Doing so may damage the instrument and result in bodily injury.

Fuse type: FF0.5 AH/1000 V (70 172 40.0.500: SIBA GmbH) (Fast blow, arc-extinguishing material included, and high breaking capacity)

The fuses can be purchased via authorized Hioki distributor or reseller. (Fuse replacement not required for the IR4053 or IR4055)

- To prevent instrument damage or electric shock, use only the screw for securing the battery cover in place that are originally installed. If you have lost a screw or find that a screw is damaged, please contact your authorized Hioki distributor or reseller.

 **CAUTION**

Poor performance or damage from battery leakage could result. Observe the cautions listed below.



- Do not mix old and new batteries, or different types of batteries.
- Pay attention to the polarity markings “+” and “-”, so that you do not insert the batteries the wrong way around.
- Do not use batteries after their recommended expiry date.
- Do not leave depleted batteries inside the instrument.
- Replace batteries only with the specified type.
- Use batteries with low internal resistance.

- The battery indicator blinks when the remaining battery capacity is low. In this case, measurement is not possible. Replace the batteries with new ones. (p.29)
- Handle and dispose of batteries in accordance with local regulations.

Procedure (The illustration shows the IR4056)

You will need:

- LR6 Alkaline battery ×4
- Phillips-head screwdriver (No. 2)

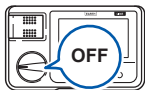

1 Turn off the rotary switch and remove the test lead from the instrument.

Rear

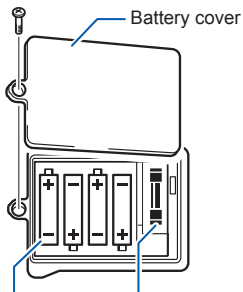

2 Loosen the fastening screw and remove the battery cover.

3 Replace all four batteries or the fuse.

4 Slide the battery cover back into place and tighten the screw.

| | |
|---|--|
| Batteries (LR6 ×4) Check the polarity. | Fuse FF0.5 AH/1000 V (70 172 40.0.500: SIBA GmbH) |
|---|--|

2.2 Using the L9788-10 Test Lead with Remote Switch (Red)

Pre-measurement inspection

- 1 Turn off the rotary switch.
- 2 Fully insert the L9788-10 plug into the **LINE** terminal of the instrument.

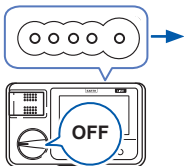

- 3 Short the test lead tips each other.



- 4 Set the rotary switch to insulation resistance range.

- 5 Turn on the **MEASURE** key of the L9788-10.

Check the red indicator of the **MEASURE** key of L9788-10 and display 0 MΩ interlocked with the live wire warning indicator of the instrument.



- 6 Press **LIGHT** .

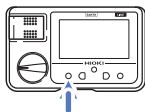

Check that the L9788-10 tip lamp lights up.

Replacing the Tip Pin (optional) for the L9788-10

When the tip pin of the L9788-10 Test Lead with Remote Switch (Red) (option) is worn out or broken, it can be replaced. The tip pin can be purchased via authorized Hioki distributor or reseller.

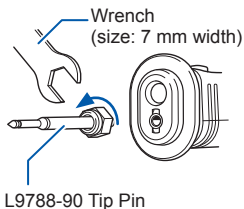

- 1 Turn off the rotary switch and disconnect the L9788-10.**
- 2 Remove the tip pin by rotating with a wrench.**
- 3 Attach the new tip pin to the L9788-10 by rotating with a wrench.**
(Tightening torque: 0.3 N·m)
- 4 Check the operation.**
Measure a measuring object of known values and use after checking that the resistance is correct.

Attaching the L9788-92 Breaker Pin

Remove the sleeve of the L9788-10 and attach the breaker pin.

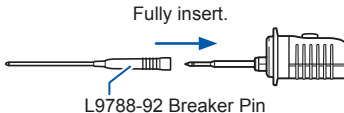

Removing and attaching the test lead sleeves

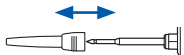

Safely store the removed sleeves so as not to lose them. (p. 12)

| Removing the sleeves | Attaching the sleeves |
|---|---|
| Hold the bottom of the sleeves and pull the sleeves off. (For safety reasons, the cap has been manufactured to fit snugly so that it cannot be easily removed.) | Insert the metal pins of the test leads into the holes of the sleeves, and firmly push them all the way in. |

2.3 Installing the Z3210 Wireless Adapter (IR4057-50 only)

2

The wireless communications function can be used by installing the Z3210 Wireless Adapter (option) to the instrument.

WARNING



- To avoid electric shock, turn off the **MEASURE** key and remove the test leads from the measuring object before removing the battery cover.



- After installing or removing the Z3210, be sure to reattach the battery cover and secure it in place with the screw before using the instrument.
- To prevent instrument damage or an electric shock, use only the screws that are originally installed for securing the battery cover in place. If you have lost any screws or find that any screws are damaged, please contact your authorized Hioki distributor or reseller.

CAUTION



After touching any metallic part, such as a doorknob, to eliminate static electricity from your body, connect or disconnect the Z3210. Failure to do so could cause static electricity to damage the Z3210.

Procedure

You will need:

- Phillips-head screwdriver (No. 2)
- Flat-head screwdriver
- Z3210 Wireless Adapter (option)

Rear

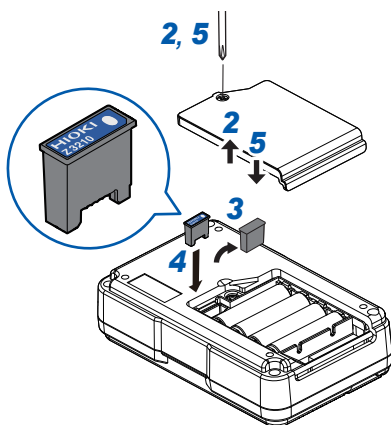

- 1** Turn off the rotary switch and remove the test leads.
- 2** Unscrew the screws and remove the battery cover.
- 3** Remove the protective cap with a flat-head screwdriver.
- 4** Exercising care to orient the Z3210 correctly, install the Z3210 as far as it will go.
- 5** Reattach the battery cover and tighten the screws.

3

Measurement

3.1 Pre-measurement Inspection

Before using the instrument, verify that it operates normally to ensure that no damage occurred during storage or shipping. If you find any damage, contact your authorized Hioki distributor or reseller.

Checking the remaining battery charge

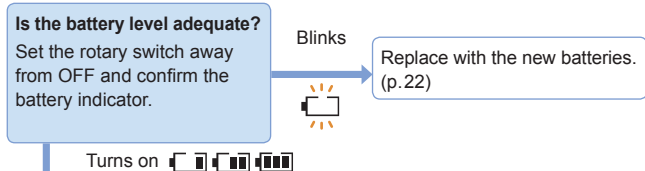

Checking the test lead

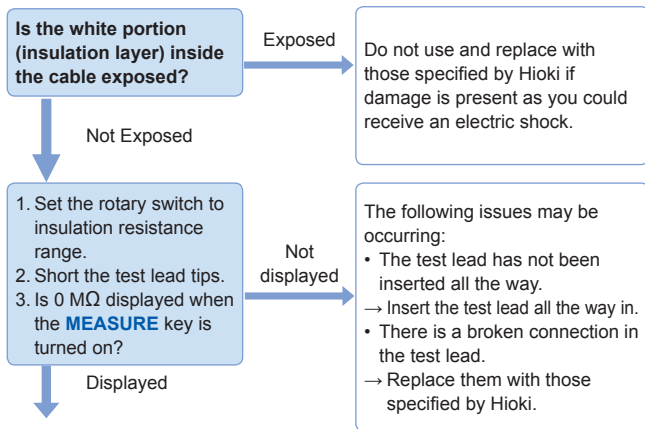

Inspection complete

Please read the “Operating Precautions” (p. 9) before use.

3.2 Auto Power Save (Power-Saving Function)

When the rotary switch is not in the OFF position, the instrument changes to the auto power save state approx. 10 minutes after the last operation or live wire warning indication.

To avoid battery depletion, turn off the rotary switch after use (the auto power save consumes a small amount of current).

Canceling the auto power save

Other than the OFF position.

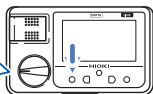

Turn on the instrument while holding down **LIGHT**.



Recovering from auto power save state

Set the rotary switch to OFF and then return it to its original position.

3.3 Auto Backlight-off (Automatic Light-off Function)

The backlight of the instrument will automatically turn off after approx. 3 minutes has passed since the last operation.

The automatic light-off function can be canceled when working continuously in a dark location.

Canceling the automatic light-off function

Backlight: OFF

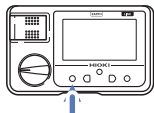

Continuous short beep

Press for approx. 2 seconds.

Set the rotary switch to any position other than OFF. With the backlight off, press **LIGHT** for approx. 2 seconds until the instrument beeps.



The automatic light-off function is enabled by setting the rotary switch to OFF.





3.4 Comparator Function

This function compares the measured value with the preset value and judges whether the result is PASS (good) or FAIL (defective).

Comparator settings for each range will be saved, even if the rotary switch is turned off.

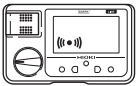
See the table on the next page for criteria that can be set.

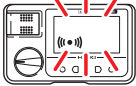
Indication lights up

| | PASS (good) judgment | | FAIL (defective) judgment | |
|-------------|---|---|---|---|
| LED display |  |  |  |  |
| | Backlight: No change | Lights up in green* | Backlight: Lights up in red | Lights up in red* |

* When using the L9788-10 Test Lead with Remote Switch (Red)

Type of measurements that can be judged

| Function | PASS judgment | | FAIL judgment | |
|-----------------------|---------------------------|------------|------------------|------------|
| | State of measured value | Buzzer | Backlight | Buzzer |
| Insulation Resistance | Criterion or higher | Short beep | Lights up in red | Long beep |
| Low resistance | Criterion or lower | Long beep | | Short beep |
| PVΩ | Criterion or higher | Short beep | | Long beep |
| Voltage | Comparator cannot be set. | | | |

Setting the Comparator

1 Select a judgment reference from the table below.



| Range | Reference value | | | | | | Unit |
|----------------------------------|------------------|-------------------|------|-------------------|------|-----|------|
| 50 V | 0.01 | 0.02 | 0.03 | 0.04 | 0.05 | | MΩ |
| | 0.1 | 0.2 | 0.3 | 0.4 | 0.5 | – | |
| | 1* ¹ | 2 | 3 | 4 | 5 | – | |
| | 10 | – | – | – | – | Off | |
| 125 V | 0.1 | 0.2 | 0.3 | 0.4 | 0.5 | – | |
| | 1* ¹ | 2 | 3 | 4 | 5 | – | |
| | 10 | 20 | – | – | – | Off | |
| 250 V | 0.1 | 0.2 | 0.3 | 0.4 | 0.5 | – | |
| | 1* ¹ | 2 | 3 | 4 | 5 | – | |
| | 10 | 20 | 30 | 40 | 50 | Off | |
| 500 V/PVΩ 500 V | 0.1 | 0.2* ² | 0.3 | 0.4 | 0.5 | – | |
| | 1* ¹ | 2 | 3 | 4 | 5 | – | |
| | 10 | 20 | 30 | 40 | 50 | – | |
| | 100 | – | – | – | – | Off | |
| 1000 V* ³ /PVΩ 1000 V | 0.1 | 0.2 | 0.3 | 0.4* ² | 0.5 | – | |
| | 1 | 2 | 3 | 4 | 5 | – | |
| | 10* ¹ | 20 | 30 | 40 | 50 | – | |
| | 100 | 200 | 300 | 400 | 500 | Off | |
| Ω | 0.1 | 0.2 | 0.3 | 0.4 | 0.5 | 0.6 | Ω |
| | 1 | 2 | 3 | 4 | 5 | 6 | |
| | 10 | 20* ¹ | 30 | 40 | 50 | 60 | |
| | 100 | 200 | – | – | – | Off | |

*1: Factory default setting

*2: Factory default setting when PVΩ function is selected.

*3: Reference values 0.1 to 0.5 are only for models IR4053 and IR4055.

2 Set the rotary switch to the range for which you wish to set the judgement reference.

| Range | Operation |
|-----------------|--|
| 500 V 1000 V | Press  to release the lock. |
| PVΩ | Press  to select the applied voltage and press  to release the lock. |

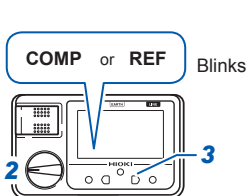

3 Press .

[COMP] or [REF] blinks and the resistance value that will be used as the judgement reference is displayed.

IR4053, IR4055, IR4056: REF
IR4057-50: COMP

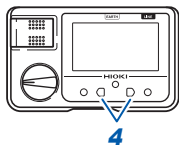

4 Press or to select the judgement reference.

If there is no operation for about 2 seconds after you select the judgment reference, the comparator will be set, and [COMP] or [REF] will light up.

Canceling the Comparator

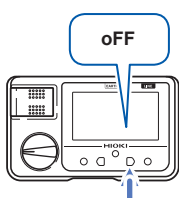

Press  several times to select [OFF].

If there is no operation for for about 2 seconds after you select, [COMP] or [REF] will go off, and the comparator function will be canceled.

3.5 Insulation Resistance Measurement

The instrument is used to measure the insulation resistance to determine the insulation performance of circuits and equipment. Before starting a measurement, the voltage to be applied to the measuring object needs to be selected.

WARNING

Observe the following to avoid electric shock, short circuit, or damage to the instrument.

- **Do not attempt to measure insulation resistance on a live conductor. Doing so could damage the instrument or cause an accident that might result in injury or death. Always turn off power to the measuring object before starting.**
- **When measuring insulation resistance, dangerous voltage is applied to the measurement terminals. To avoid electric shock, do not touch the metal part of the test leads.**
- **Do not touch the measuring object immediately after measurement. Doing so may cause electric shock due to a highly charged voltage.**
- **Discharge the measuring object with the discharge function of the instrument after a measurement. (p.39)**



- Insulation resistance is the ratio of applied voltage to leakage current. Displayed value may not stabilize depending on the measuring object, but it is not a failure of the instrument.
- Press the **MEASURE** key fully down until a live circuit indicator lights up. If the button is not pressed down fully, a proper measurement cannot be made.
- Turn off the rotary switch after use.
- Disconnection when measuring is recommended of any equipment having a lower withstanding voltage than the test voltage, or equipment or parts having an unknown withstanding voltage connected to the circuit to be measured.

Lock Function

This function is used to avoid applying high voltage such as 500 V or 1000 V to equipment having a lower withstanding voltage. This function will prevent the test voltage from being output even if the **MEASURE** key is pressed while the rotary switch is set to the 500 V, 1000 V or PVΩ range.

Releasing the lock

3

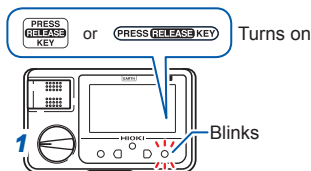

- 1** Set the rotary switch to the 500 V, 1000 V or PVΩ range.

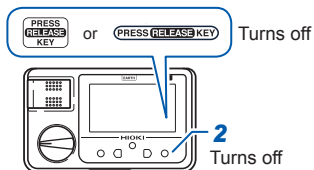

- 2** Press  .
Pressing this key unlocks the instrument and switches to the measurement screen.

The screen is locked 1 minute after the last measurement or operation again.

Measuring Insulation Resistance

⚠ CAUTION



To avoid electric shock, turn off the measuring line breaker.

Example: When measuring the insulation resistance between the circuit and the ground



1 Turn off the **MEASURE** key.

2 Set the rotary switch to a test voltage of 50 V to 1000 V.

In the 500 V or 1000 V range, press  to release the lock. (p.35)

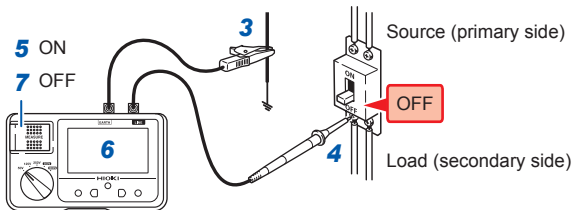

3 Connect the black test lead to the ground side of the object being measured.

4 Connect the red test lead to the measuring object.

If there is any remaining voltage on the measuring object, red and white blink alternately on the backlight.

5 Press and hold the **MEASURE** key.

To make continuous measurements, pull up the **MEASURE** key. (p.16)

6 Check the value after the indicator has stabilized.

7 Turn off the **MEASURE** key with the test leads connected to the measuring object.

The last measured values and **HOLD** are displayed and starts discharging. (p.39)

- Do not switch the function to other function or rated voltage when the measurement is in progress.
- The instrument will return to the locked state when about 1 minute of no operation elapses during measurement in the 500 V and 1000 V ranges. To continue measurement, release the lock. (p.35)

Displaying 1-minute Values (IR4057-50 only)

3

This function is only available on the IR4057-50.

The function cannot be used if the comparator function has been enabled. Disable the comparator function before use. (p. 33)

This function automatically retains the measured value (1-minute value) 1 minute after the start of measurement (after the **MEASURE** key is turned on). Use this function when measuring a object such as a cable that includes a capacitance component.



Retained measured value

- No value is shown if less than 1 minute has elapsed since the start of measurement.

Voltage Characteristics of Measurement Terminals

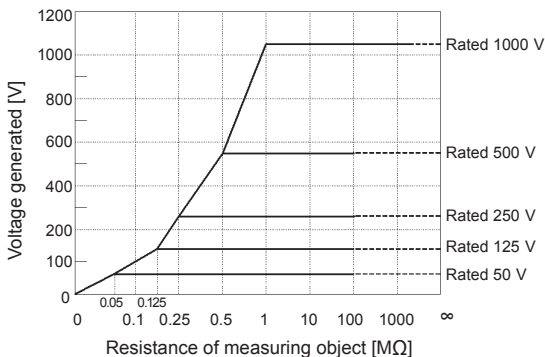

3.6 Discharging Function

After measurements are completed, discharge the measuring object. When objects with capacitance component are measured, a charge equivalent to the rated measurement voltage remains in the object that may cause electric shock.

When measuring a solar panel, ⚡ mark may not disappear since the instrument will continue to detect the panel's voltage once discharging ends.

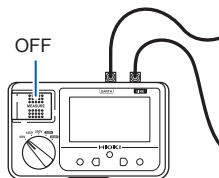

Without removing the test leads from the measuring object, turn off the **MEASURE** key.

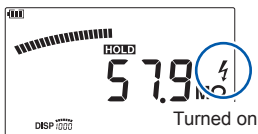

Discharging

The built-in discharge resistor automatically discharges the item.

In the IR4057-50, the bar graph level decreases according to discharge. However, measuring objects with smaller capacitance component discharge quickly and the bar graph level may not change.

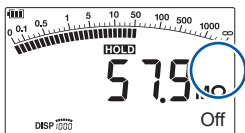

Discharged

When the discharge is completed, ⚡ mark is turned off.

The time required for discharge depends on the capacitance value.

3.7 Voltage Measurement

This instrument can measure the AC voltage and DC voltage of commercial power. The instrument can check to ensure that the measuring object is not live before measuring insulation resistance.

- During measuring, do not switchover to other functions.
- For waveforms other than sine waves, some errors may occur.
- Displayed values can frequently fluctuate due to induction potential even when no voltage is applied. This, however, is not a malfunction.

Example: When measuring the voltage between the circuit and ground

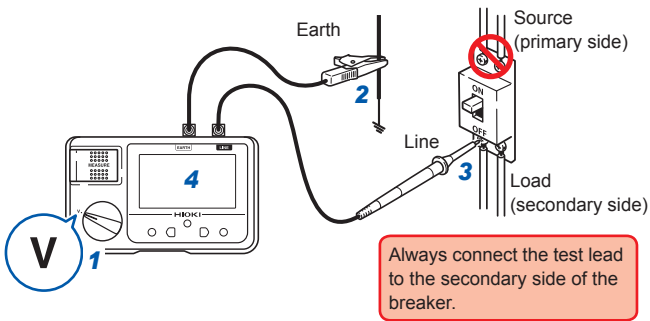

- 1** Set the rotary switch to V.
- 2** Connect the black test lead to the earth side of the object being measured.
- 3** Connect the red test lead to the line side of the breaker.
- 4** Check the value after the indicator has stabilized.

Negative Voltage Notification Function (IR4053 and IR4055 only)

This function is only available on the IR4053 and the IR4055. You can check whether P and N are connected in reverse while measuring the open voltage of solar battery string.

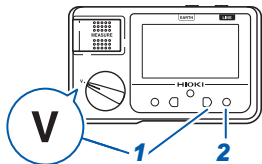

- 1** Set the rotary switch to V while pressing .

The [-] and [V] blinks and [ON] or [OFF] is displayed.

3

- 2** Press  to switch between ON and OFF.

| | |
|--------------------------------|---|
| ON (Factory setting) | When the voltage is -1 V or lower, red and white of the backlight blinks alternately. |
| OFF | Disabled |

If there is no operation for approx. 2 seconds after ON or OFF is selected, the setting is confirmed, and the screen changes to measurement screen.

3.8 Low Resistance Measurement (IR4056 and IR4057-50 only)

This function is only available on the IR4056 and the IR4057-50.

WARNING



Do not measure under a live circuit condition.

CAUTION



- If active circuits are connected to the measuring object circuit in parallel, the impedance and transient current of the parallel circuit could cause measurement errors.
- Auto range selection may not operate in a stable manner depending on the measuring object (for example, a motor, transformer, or coil).
- The instrument may not be able to obtain an accurate measured value if there is a capacitance component in parallel with the measuring object.

The comparator function can be used during low resistance measurement. See “3.4 Comparator Function” (p. 31)

For accurate measurements, be sure to perform zero adjustment before measuring, to cancel the wire resistance of the test leads.

Zero adjustment can be performed with readings of up to a maximum of 3 Ω . When the reading exceeds 3 Ω , [Err 1] or [Err 0QADJ] will be displayed, and zero adjustment will not be possible. Wire the instrument so that the wiring resistance is 3 Ω or less.

In the following circumstances, repeat the zero adjustment procedure:

- After changing test leads
- When the ambient temperature changes by 1°C or more
- After replacing the fuse

Example: Checking continuity of grounding wire

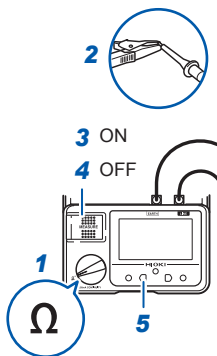

- 1 Set the rotary switch to the Ω .
- 2 Short circuit the tip of the test lead.
- 3 Turn on the **MEASURE** key.
- 4 Turn off the **MEASURE** key to retain the measured value.
- 5 Press .

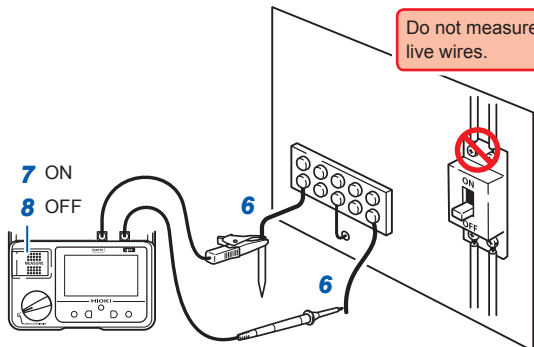

- 6 Connect the test lead to the measuring object.
- 7 Press and hold the **MEASURE** key to check the displayed value.
To make continuous measurements, pull up the **MEASURE** key.
- 8 Turn off the **MEASURE** key after measurement.

3

3.9 PVΩ Measurement Function (IR4053 and IR4055 only)

This function is only available on the IR4053 and the IR4055. This function allows accurate insulation resistance measurements between the solar panel and ground without any influence from power generation. For measurements between the coupling box output terminals and ground or between power conditioner and ground, use the normal insulation resistance range. See “Appx. 1 Measurement Principles” (p. Appx.1)

DANGER



Do not cause a short-circuit between another wire and the wire to be measured with the test leads. Arcs or such grave accidents are likely to occur.

WARNING

Observe the following to avoid electric shock, shortcircuit, or damage to the instrument.

- **When measuring insulation resistance, dangerous voltage is applied to the measurement terminals. To avoid electric shock, do not touch the metal part of the connecting test leads.**
- **Check that the connection of the measurement terminals has been secured. If the terminal is loose, the contact resistance will increase, resulting in overheating, equipment burnout, or fire.**
- **Do not touch the measuring object immediately after measurement. A highly charged voltage may cause electric shock.**
- **Discharge the measuring object with the discharge function of the instrument after a measurement. (p.39)**

 **WARNING**

Observe the following to avoid electric shock, short circuit, or damage to the instrument.

- Turn off any disconnecter devices and separate from the power conditioner before starting the measurements for the solar battery panel.
- Do not attempt to measure insulation resistance on a live conductor. Doing so could damage the instrument or cause an accident that might result in injury or death. Always turn off power to the measuring object before starting.
- Photovoltaic cells produce electricity continuously during daylight hours, resulting in hazardous voltages. Exercise care during measurement to avoid electric shock.
- Do not touch any metal parts such as connection box and disconnecter devices directly with bare hands. Doing so may cause electric shocks due to the voltage of the generator.
- Maximum rated voltage between terminals of the IR4053 and IR4055 is 1000 V DC/600 V AC. Do not use the instrument for equipment with rated voltage over 1000 V DC or 600 V AC. Doing so may cause electric shock or failure.
- If the solar battery panel has failed, do not perform any insulation resistant measurement. Doing so may damage the bypass diode of the solar battery panel.



- Insulation resistance is the ratio of applied voltage to leakage current. Displayed value may not stabilize depending on the measuring object, but it is not a failure of the instrument.
- Press the **MEASURE** key fully down until a live circuit indicator lights up. If the button is not pressed down fully, a proper measurement cannot be made.
- Turn off the rotary switch after use.
- Disconnection when measuring is recommended of any equipment having a lower withstanding voltage than the test voltage, or equipment or parts having an unknown withstanding voltage connected to the circuit to be measured.
- The ground capacitance of the solar battery panel is high, therefore the measured values may take some time to stabilize.
- Accurate measurements are not possible when open voltage of the solar battery string is higher than the test voltage. Use the PVΩ 500 V range for open voltage 500V or less and PVΩ 1000 V range for open voltage 1000 V or less.
- If a voltage higher than the test voltage is detected, the buzzer sounds and measurement is not possible.
- Use an insulation resistance range other than PVΩ to perform measurements by shorting P and N.
- Perform measurements by shorting P and N when the solar battery panel is not generating power, such as during the night.
- For the PVΩ measurement function, the output voltage is divided by the 1 MΩ resistor and the resistor connected between measurement terminals because a 1 MΩ current limiting resistor is connected to the **EARTH** terminal.
Example: When a 10 MΩ resistor is measured, the voltage is divided by 1 MΩ and 10 MΩ.



The method to measure the insulation resistance between the solar battery panel and ground without shorting P and N will be explained. See “Appx. 3 Insulation Resistance Measurements for Solar Cell Array” (p. Appx.3)

Measurement preparation 1

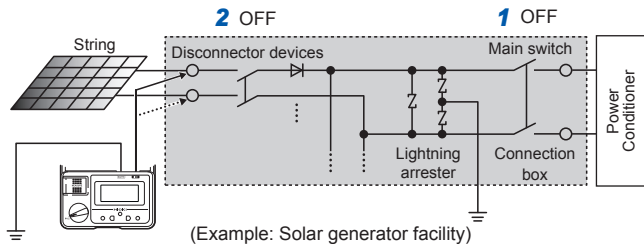
- 1 Turn off the main switch of the connection box to be disconnected from the power conditioner.**
- 2 Turn off all the disconnecter devices of the strings.**
- 3 Disconnect lightning arresters from the measuring circuit.**
Disconnection is not required for the figure (solar generator facility) shown below because a lightning arrester is not present at the string side of the disconnecter device.



Measurement preparation 2

- 1 Check that the MEASURE key is turned off.**
If the MEASURE key is on, turn it off. (p. 16)
- 2 Set the rotary switch to PVΩ.**
- 3 Press  to set 500 V or 1000 V as the test voltage.**
- 4 Press  to release the lock.**

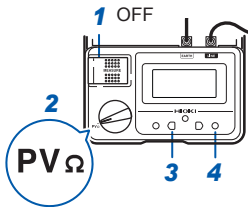

Start Measuring

WARNING

Observe the following to avoid damage to the measuring object.



- If the insulation has deteriorated between the terminal P and the ground, do not measure between the terminal N and the ground.
- Connect the red test lead to the string side of the disconnector device.

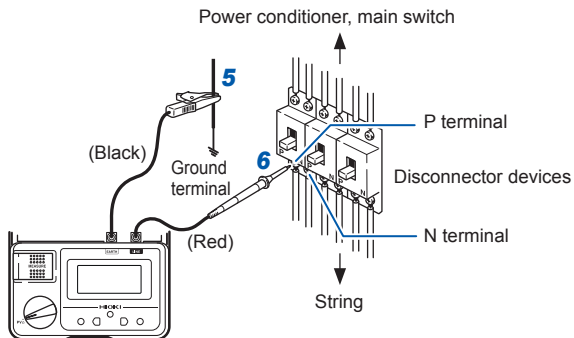

5 Connect the black test lead to the ground terminal.

6 Connect the red test lead to the terminal P of the string side.

If a voltage is detected between the P and the ground terminals, the insulation may have deteriorated. When there is a voltage on the measuring object, the voltage detection function makes the backlight light in red and white alternately.

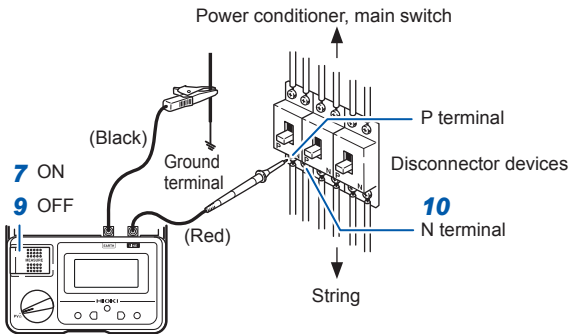

7 Press and hold the MEASURE key.

To make continuous measurements, pull up the **MEASURE** key.

Do not remove any test leads from the terminals until the resistance is displayed. Doing so results in incorrect measurements. (p.72)

8 Check the resistance displayed after approx. 4 seconds.

Subsequently, the resistance will be updated every second.

If there is any deteriorated insulation and the resistance is lower than the reference value, do not measure the terminal N of procedure 10. Doing so may damage the solar battery panel. Check the reference insulation resistance with safety regulations.

9 Turn off the MEASURE key.

If the **MEASURE** key is on, turn it off. (p.16)

Discharge starts and the ⚡ mark blinks. The ⚡ mark may not be cleared even if the discharge is completed because a voltage is generated by the solar battery.

10 When measuring terminal P and insulation has not deteriorated, connect the red test lead to the terminal N of the string side and repeat the procedures 7 to 9.

After Measurements

- 1** After measuring insulation resistance for all the strings, remove the black test lead from the ground terminal.
- 2** Reconnect the lightning arrester connection if disconnected.
- 3** Turn on all the disconnecter devices of the strings.
- 4** Turn on the main switch of the connection box.

1 minute after the last measurement or operation, the  turns on and the **500 V/1000 V RELEASE** key blinks. Press the key to release the lock.

3.10 Wireless Communications Function

Using the GENNECT Cross (IR4055 and IR4057-50 only)

This function cannot be used at the same time as the HID function.
(p.55)

When the wireless communications function is enabled, you can review measurement data and create measurement reports on mobile devices. For details, see the Help function in the GENNECT Cross (application software, free of charge).



GENNECT Cross Official Website
<https://gennect.net/en/cross/index>



3

- 1 (IR4057-50 only) Install the Z3210 Wireless Adapter (option) to the instrument. (p.27)**
- 2 Install the GENNECT Cross on your mobile device.**
- 3 Turn on the IR4055 or IR4057-50 to enable the wireless communications function.**

mark or mark

On: Enabled

Off: Disabled

Blinks: Communicating

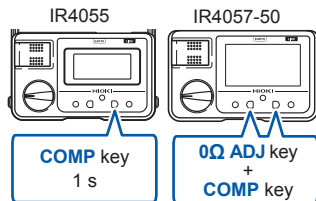

- 4 Launch the GENNECT Cross and pair it with model IR4055 or IR4057-50. (p.52)**

5 Select the standard measurement function and start measurement.



- The communication distance is approx. 10 m (line of sight). The distance over which data can be sent and received varies greatly depending on whether there are any obstructions between the paired instruments (for example, walls, metal barriers, etc.) and on the distance between the instrument and the floor (or ground). To ensure stable communication, verify adequate signal strength.
- Although the GENNECT Cross is provided free of charge, downloading or using the application software may incur Internet connection charges. Such charges are the sole responsibility of the user.
- The GENNECT Cross is not guaranteed to operate on all mobile devices.
- The Z3210 uses 2.4 GHz band wireless technology. It may not be possible for the device to establish a wireless connection when used in the vicinity of other devices that use the same frequency band, for example Wi-Fi devices (IEEE 802.11.b/g/n).

Pairing the App

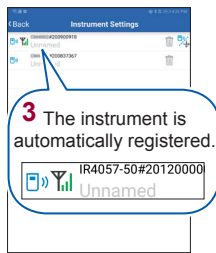
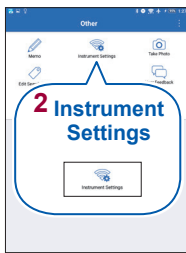

- When the app is launched for the first time (before being paired with any instrument), the connection setup screen will be displayed.
- While the mobile device is displaying the connection setup screen, simply move it close to the IR4055 or the IR4057-50 to automatically pair it with the instrument (the app can be paired with up to 8 instruments).
- Allow about 5 to 30 seconds for the instrument to pair with the app after being turned on. If the instrument fails to pair within 1 minute, relaunch GENNECT Cross and cycle the instrument's power.
- Instruments that have been registered do not require to be registered again.

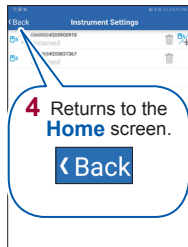

3

Making Measurements with the Wireless Communications Function

On the home screen, select the standard measurement function from the options, standard measurement, logging and waveform display, to start a measurement. For more information about each function, see the help function in the GENNECT Cross.

The values displayed by the instrument may be different from the values displayed by the application software due to communication delays or differences in the update timing.

Standard measurement

Measured values of multiple channels are saved.

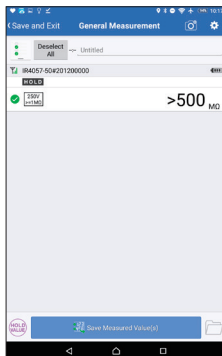

Excel® Direct Input Function (HID function) (IR4057-50 only)

This function cannot be used at the same time as GENNECT Cross (p.51).

The human interface device (HID) profile, with which the Z3210 Wireless Adapter is equipped, is a profile same as that wireless keyboards use.

| | |
|---------|---|
| HID ON | Preparatory to data entry, open an Excel® file on your mobile device or computer and choose a cell. Freezing the instrument's display can enter the measured values on the cells. |
| HID OFF | Select this setting when using GENNECT Cross. |

The setting whether the HID function has been enabled or disabled will not be saved in the instrument but in the Z3210.

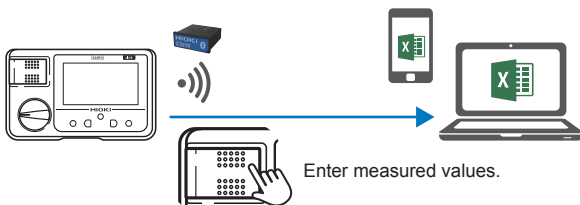

Measured value input method

Insulation resistance, low resistance:

Press and release the **MEASURE** key.

Voltage: Press the **MEASURE** key.

Checking and changing the HID setting

1 Set the rotary switch to OFF.

2 Install the Z3210 Wireless Adapter (option) to the instrument.

See “2.3 Installing the Z3210 Wireless Adapter (IR4057-50 only)” (p. 27)

If the wireless communications function is off, you won't be able to check or change the HID setting. Enable the wireless communications function first before attempting to check or change the HID setting (Step 3 on p. 51).

3 Check the HID setting.

Turn on the instrument while holding down the **RELEASE** key to display the serial number screen.

Press and hold the **RELEASE** key for at least 3 s to display the HID setting saved by the Z3210.

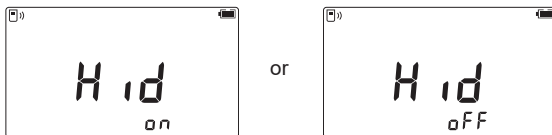

To leave the HID setting unchanged

Set the rotary switch to OFF.

To change the HID setting

Proceed to Step 4.

If the instrument beeps and the display doesn't change

Using GENNECT Cross (Ver. 1.8 or later), update the Z3210 to the latest version.

4 Change the HID setting.

Toggle the HID setting on and off by pressing the **0 Ω ADJ** key or the **COMP** key.

5 Accept the setting

Press the **RELEASE** key to accept the HID setting. The instrument will automatically turn off.

IMPORTANT**To switch from the HID function to GENNECT Cross**

If you launch GENNECT Cross without unpairing the mobile phone and the instrument, the application may fail to recognize the instrument as a connected device.

Reconnect the instrument to GENNECT Cross as follows:

1. Delete the instrument from your device's **Bluetooth**® settings.
2. Turn off the Z3210's HID function. (p.56)
3. Reconnect the instrument using GENNECT Cross's connected device settings.

3

For details, please check the Z3210's website.
<https://z3210.gennect.net>



▲
Learn more here!

4

Specifications

4.1 General Specifications

Operating environment

Indoors, Pollution Degree 2,
altitude up to 2000 m (6562 ft.)

Operating temperature and humidity

- IR4053, IR4055
0°C to 40°C (32°F to 104°F), 90% RH or less (no condensation)
40°C to 50°C (104°F to 122°F), at 50°C and below relative with linear decrease up to 50% RH (no condensation)
- IR4056, IR4057-50
-25°C to 40°C (-13°F to 104°F), 90% RH or less (no condensation)
40°C to 65°C (104°F to 149°F), at 65°C and below relative with linear decrease up to 25% RH (no condensation)

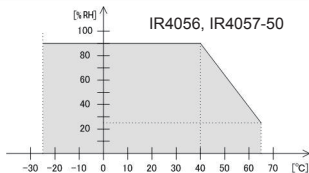
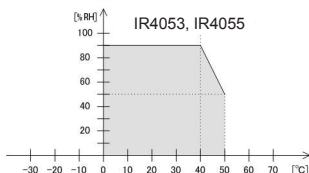
**Storage temperature and humidity**

- IR4053, IR4055
-10°C to 50°C (-13°F to 122°F), 90% RH or less (no condensation)
- IR4056, IR4057-50
-25°C to 65°C (-13°F to 149°F), 90% RH or less (no condensation)

Dustproof and waterproof

IP40 (EN 60529)

Drop proof

On concrete: 1 m

| | |
|--|---|
| Standards | <p>EMC: EN 61326</p> <p>Safety: EN 61010</p> <p>EN 61557-1</p> <p>EN 61557-2</p> <p>EN 61557-4*1*2</p> <p>EN 61557-10*2</p> <p>Insulation resistance testers: JIS C 1302*3</p> |
| <p>*1: Subclause 4.3 of Part 4 (Interchanging of test leads) is not applicable when model L9788-10 is used.</p> <p>*2: The IR4053 and the IR4055 are not applicable.</p> <p>*3: IR4053 and IR4055 only</p> | |
| Power supply | <p>LR6 Alkaline battery ×4</p> <p>Rated supply voltage: 1.5 V DC ×4</p> <p>Maximum rated power: 3 VA</p> |
| Continuous operating time | <p>Approx. 20 hours (without Z3210 installed, comparator off, backlight off, measured with measurement terminal open at 500 V range)</p> <p>When using four LR6 Alkaline batteries (reference value at 23°C)</p> <p>Approx. 15 hours (with Z3210 installed, using wireless communications, comparator off, backlight off, measured with measurement terminal open at 500 V range)</p> |
| Dimensions (excluding protrusions) | <p>Approx. 159W × 177H × 53D mm</p> <p>(6.26"W × 6.97"D × 2.09"D)</p> |
| Mass (including battery, excluding test lead) | <ul style="list-style-type: none"> • IR4053, IR4055, IR4056: Approx. 600 g (21.2 oz.) • IR4057-50: Approx. 640 g (22.6 oz.) |
| Product warranty period: 3 years | |
| Fuse (Replacements) | <p>FF0.5 AH/1000 V (70 172 40.0.500: SIBA GmbH)</p> <p>(Very fast-blow, arc-extinguishing material included, high breaking capacity) (IR4056 and IR4057-50 only)</p> |
| Accessories | See "Verifying Package Contents" (p. 1) |
| Options | See "Options" (p. 2) |

4.2 Basic and Accuracy Specifications

| | |
|--|---|
| Measurement item | <p>Insulation Resistance measurement: DC voltage supply, current detection</p> <p>Low resistance measurement: DC current supply, voltage detection (IR4056 and IR4057-50 only)</p> <p>Voltage measurement: Automatic DC/AC detection AC voltage measurement rectification method: Mean rectification RMS value indication</p> <p>PVΩ measurement: DC voltage supply, current detection (IR4053 and IR4055 only)</p> |
| Maximum rated voltage to terminal | <p>600 V AC/DC (Voltage measurement) 600 V AC/1000 V DC (Voltage measurement, IR4053 and IR4055 only)</p> |
| Maximum rated voltage to earth | 600 V AC/DC, Measurement Category III, Anticipated Transient Overvoltage: 6000 V |
| Rated operational conditions | <p>Position: Standard position $\pm 90^\circ$ External magnetic field: 400 A/m or less Battery voltage: Available effective battery voltage</p> |
| Nominal circuit voltage* | <p>600 V AC/DC max. *: The nominal circuit voltage refers to the nominal voltage of an electric distribution circuit that can be measured by the instrument (based on EN 61557).</p> |
| Accuracy guarantee conditions | <p>Accuracy guarantee period: 1 year Accuracy guarantee period after adjustment made by Hioki: 1 year Accuracy guarantee temperature and humidity range: $23^\circ\text{C}\pm 5^\circ\text{C}$ ($73^\circ\text{F}\pm 9^\circ\text{F}$), 90% RH or less Position: Standard position $\pm 5^\circ$ External magnetic field: None (Earth's magnetic field) Battery voltage: Available effective battery voltage</p> |

| Insulation Resistance Measurement | | | | | |
|---|---|----------------|----------------|-----------------|-----------------|
| Rated measurement voltage (DC) | 50 V | 125 V | 250 V | 500 V | 1000 V |
| Effective maximum displayed value | 100 M Ω | 250 M Ω | 500 M Ω | 2000 M Ω | 4000 M Ω |
| Medium displayed value | 2 M Ω | 5 M Ω | 10 M Ω | 50 M Ω | 100 M Ω |
| 1st effective measuring range [M Ω] | 0.200 to 10.00 | 0.200 to 25.0 | 0.200 to 50.0 | 0.200 to 500 | 0.200 to 1000 |
| Accuracy (Tolerance) | IR4053, IR4055: $\pm 4\%$ rdg IR4056, IR4057-50: $\pm 2\%$ rdg ± 2 dgt | | | | |
| 2nd effective measuring range [M Ω] | 10.1 to 100.0 | 25.1 to 250 | 50.1 to 500 | 501 to 2000 | 1010 to 4000 |
| Accuracy (Tolerance) | IR4053 and IR4055: $\pm 8\%$ rdg IR4056, IR4057-50: $\pm 5\%$ rdg | | | | |
| Other measuring range [M Ω] | 0 to 0.199 | | | | |
| Accuracy (Tolerance) | $\pm 2\%$ rdg ± 6 dgt | | | | |

| Insulation Resistance Measurement (continued) | | | | | | |
|---|-------------------------|----------|----------|----------|----------|----------|
| Range configuration | Display range | 1 MΩ | 1 MΩ | 1 MΩ | 1 MΩ | 1 MΩ |
| | Maximum displayed value | 1.000 MΩ | 1.000 MΩ | 1.000 MΩ | 1.000 MΩ | 1.000 MΩ |
| | Resolution | 0.001 MΩ | 0.001 MΩ | 0.001 MΩ | 0.001 MΩ | 0.001 MΩ |
| | Display range | 10 MΩ | 10 MΩ | 10 MΩ | 10 MΩ | 10 MΩ |
| | Maximum displayed value | 10.00 MΩ | 10.00 MΩ | 10.00 MΩ | 10.00 MΩ | 10.00 MΩ |
| | Resolution | 0.01 MΩ | 0.01 MΩ | 0.01 MΩ | 0.01 MΩ | 0.01 MΩ |
| | Display range | 100 MΩ | 100 MΩ | 100 MΩ | 100 MΩ | 100 MΩ |
| | Maximum displayed value | 100.0 MΩ | 100.0 MΩ | 100.0 MΩ | 100.0 MΩ | 100.0 MΩ |
| | Resolution | 0.1 MΩ | 0.1 MΩ | 0.1 MΩ | 0.1 MΩ | 0.1 MΩ |
| | Display range | – | 250 MΩ | 500 MΩ | 1000 MΩ | 1000 MΩ |
| | Maximum displayed value | – | 250 MΩ | 500 MΩ | 1000 MΩ | 1000 MΩ |
| | Resolution | – | 1 MΩ | 1 MΩ | 1 MΩ | 1 MΩ |
| | Display range | – | – | – | 2000 MΩ | 4000 MΩ |
| | Maximum displayed value | – | – | – | 2000 MΩ | 4000 MΩ |
| | Resolution | – | – | – | 10 MΩ | 10 MΩ |

| Insulation Resistance Measurement (continued) | | | | | |
|---|---|-------|--|-------|--|
| | 1st effective measuring range | | 2nd effective measuring range | | Other measuring range |
| Fluctuations caused by temperature effects (E_3)* | $\pm 4\%$ rdg (0°C to 50°C) | | $\pm 8\%$ rdg (0°C to 50°C) | | $\pm 2\%$ rdg ± 6 dgt (0°C to 50°C) |
| | $\pm 8\%$ rdg (Greater than or equal to -25°C and less than 0°C, or greater than 50°C and less than or equal to 65°C) (Only for IR4056 and IR4057-50) | | $\pm 16\%$ rdg (Greater than or equal to -25°C and less than 0°C, or greater than 50°C and less than or equal to 65°C) (Only for IR4056 and IR4057-50) | | $\pm 4\%$ rdg ± 12 dgt (Greater than or equal to -25°C and less than 0°C, or greater than 50°C and less than or equal to 65°C) (Only for IR4056 and IR4057-50) |
| Effect of humidity | $\pm 4\%$ rdg and within allowance | | $\pm 8\%$ rdg and within allowance | | $\pm 2\%$ rdg ± 6 dgt |
| Effect of magnetic field | $\pm 2.4\%$ rdg | | - | | - |
| Fluctuations caused by positioning effect (E_1) | Not applicable | | | | |
| Fluctuations caused by supply voltage effects (E_2) | $\pm 4\%$ rdg and within allowance | | $\pm 8\%$ rdg and within allowance | | $\pm 2\%$ rdg ± 6 dgt and within allowance |
| Effects of capacitance components | Within $\pm 10\%$ for capacitance of 5 μF or less (including variation) | | | | |
| *: Applicable to the operating temperature range other than 18°C to 28°C. | | | | | |
| Rated measurement voltage (DC) | 50 V | 125 V | 250 V | 500 V | 1000 V |
| Possible number of measurements | 1000 times or more | | | | |
| Overload protection | 600 V AC (10 s) | | | | 660 V AC (10 s) |
| | 660 V AC (10 s), 1200 V DC (10 s) (IR4053 and IR4055 only) | | | | |

| Insulation Resistance Measurement (continued) | | | | | | |
|---|---|---|------------------|-----------------|----------------|--------------|
| Display update interval | IR4053, IR4055, IR4056: Within 1.0 s (no update during response) IR4057-50: Within 0.6 s (no update during response) | | | | | |
| Measurement terminal voltage characteristic | Open-circuit voltage | 1 to 1.2 times of rated measurement voltage | | | | |
| | Lower limit resistance value to be maintained rated measurement voltage | 0.05 M Ω | 0.125 M Ω | 0.25 M Ω | 0.5 M Ω | 1 M Ω |
| | Rated current | 1 mA to 1.2 mA | | | | |
| | Short-circuit current | 1.2 mA or less | | | | |
| Response time | IR4053, IR4055, IR4056: Within 1.0 s (with resistance load) IR4057-50: Within 0.6 s (with resistance load) | | | | | |
| Judgment time | IR4053, IR4055, IR4056: Within 0.8 s IR4057-50: Within 0.3 s (When switching from an open state to 10 times the default judgment reference value) | | | | | |

| Low Resistance Measurement (IR4056 and IR4057-50 only) | | | | |
|--|----------------------------|--|---------------|---|
| Open-circuit voltage | | 4.0 V to 6.9 V | | |
| Measuring current | | 200 mA or more (display value before zero adjustment at 6 Ω or less) | | |
| Effect of temperature* | | $\pm 3\%$ rdg ± 2 dgt (applied in the operating temperature range excluding 18°C to 28°C) | | |
| Effect of supply voltage* | | $\pm 3\%$ rdg ± 2 dgt and within allowance | | |
| Response time | | Within 1 s (measurement terminal open \rightarrow short) | | |
| Possible number of measurements | | 200 times or more | | |
| Overload protection | | 600 V AC 10 s (by fuse protection) | | |
| Zero adjustment range | | 0 Ω to 3 Ω | | |
| Display update interval | | Within 1 s | | |
| Range configuration | Display range (Auto range) | Maximum displayed value | Resolution | Accuracy* |
| | 10 Ω | 10.00 Ω | 0.01 Ω | ± 3 dgt (0 Ω to 0.19 Ω) $\pm 3\%$ rdg ± 2 dgt (0.20 Ω to 10.00 Ω) |
| | 100 Ω | 100.0 Ω | 0.1 Ω | $\pm 3\%$ rdg ± 2 dgt |
| | 1000 Ω | 1000 Ω | 1 Ω | |

*: Display value is applicable after zero adjustment

(When the temperature changes more than 1°C, zero adjustment is necessary.)

| Voltage Measurement | | | | |
|--|---|--------------------------------------|------------|--|
| AC/DC automatic detection range | AC detected at 30 V or greater (50 Hz/60 Hz). (pulsating currents with an overlapping AC component of 30 V or more are detected as AC) | | | |
| Effect of temperature | Measurement accuracy per $1^{\circ}\text{C} \times 0.1$ (applied in the operating temperature range excluding 18°C to 28°C) | | | |
| Overload protection | 750 V AC (10 s), 750 V DC (10 s) 1200 V DC (10 s) (IR4053 and IR4055 only) | | | |
| Display update interval | Within 1 s | | | |
| Response time | Within 1.2 s (when input voltage is changed from 0 V to 600 V) | | | |
| AC Voltage Measurement | Input resistance | 100 k Ω or more (50 Hz/60 Hz) | | |
| | Frequency range | 50 Hz/60 Hz | | |
| | Range configuration | | | |
| | Display range (Auto range) | Maximum displayed value | Resolution | Accuracy |
| | 420 V (minimum displayed value: 30.0 V) | 420.0 V | 0.1 V | $\pm 2.3\%$ rdg ± 8 dgt (ranges in excess of 600 V are outside the accuracy guarantee) |
| | 600 V | 750 V | 1 V | |
| DC Voltage Measurement | Input resistance | 100 k Ω or more | | |
| | Range configuration | | | |
| | Display range (Auto range) | Maximum displayed value | Resolution | Accuracy |
| | 4.2 V | 4.200 V | 0.001 V | $\pm 1.3\%$ rdg ± 4 dgt (ranges in excess of 600 V* are outside the accuracy guarantee) |
| | 42 V | 42.00 V | 0.01 V | |
| | 420 V | 420.0 V | 0.1 V | |
| IR4053, IR4055: 1000 V IR4056, IR4057-50: 600 V | IR4053, IR4055: 1100 V IR4056, IR4057-50: 750 V | 1 V | | |

* Over 1000 V for IR4053 and IR4055 only

| PVΩ Measurement (IR4053 and IR4055 only) | | |
|--|--|---------------|
| Measurement voltage (DC) | PVΩ 500 V | PVΩ 1000 V |
| Maximum displayed value | 2000 MΩ | 4000 MΩ |
| 1st effective measuring range [MΩ] | 0.200 to 500 | 0.200 to 1000 |
| Accuracy (Tolerance) | ±4% rdg | |
| 2nd effective measuring range [MΩ] | 501 to 2000 | 1010 to 4000 |
| Accuracy (Tolerance) | ±8% rdg | |
| Other measuring range [MΩ] | 0 to 0.199 | |
| Accuracy (Tolerance) | ±2% rdg ±6 dgt | |
| Effect of temperature (E ₃) | Accuracy × 1.0 (applicable to the operating temperature range other than 18°C to 28°C) | |
| Effect of humidity | Accuracy × 1.0 and within allowance | |
| Effect of magnetic field | Accuracy × 0.5 | |
| Impact of positioning (E ₁) | Not applicable | |
| Effect of supply voltage (E ₂) | Accuracy × 1.0 and within allowance | |
| Effect of superimposing DC voltage | Within ±10% | |
| Possible number of measurements | 1000 times or more | |
| Overload protection | 660 V AC (10 s), 1200 V DC (10 s) | |
| Display update interval (no update during response) | Within 1.0 s | |
| Open voltage* | 1 to 1.2 times of rated measurement voltage | |
| Lower limit resistance value to maintain rated measurement voltage | 20 MΩ ±5% | 20 MΩ ±5% |
| Rated current | 0.025 mA ±20% | 0.05 mA ±20% |
| Short-circuit current | 1.2 mA or less | |
| Response time | Within 4.0 s (Measurement start → Display) | |
| Range configuration | See explanation for 500 V and 1000 V of the insulation resistance measurement | |

- * For the PVΩ measurement function, the output voltage is divided by the 1 MΩ resistor and the resistor connected between measurement terminals because a 1 MΩ current limiting resistor is connected to the **EARTH** terminal.
 Example: If a DMM with input impedance 10 MΩ is used to measure an open voltage, the voltage is divided by 1 MΩ and 10 MΩ.

4.3 Functionality specifications

| | |
|-------------------------------------|---|
| Live circuit indicator | Turns on when voltage is detected between the LINE terminal and the EARTH terminal |
| Automatic electric discharge | Automatically discharges the electric charge still present in the capacitance of the measuring object after the insulation resistance measurement. Bar graph display of residual voltage |
| | <ul style="list-style-type: none"> • Discharge resistance: 1.2 MΩ or less (IR4053 and IR4055) 800 kΩ or less (IR4056 and IR4057-50) • Maximum capacitive load: 5 μF • Discharge time: Max. 30 s (when connected to 5 μF) |
| Auto power save (APS) | The power will go off automatically approx. 10 minutes after the last operation or last live circuit indicator display. Can be canceled using the power supply activation options. |
| Display | Semi-transmissive FSTN liquid crystal, positive |
| Backlight | <ul style="list-style-type: none"> • Color: white, red • Light automatic OFF function: Available (3 min. after last operation) • Turns red when the comparator judgment result is FAIL. • Operation at erroneous input: Alternates white and red. |
| Firmware update function | The instrument's firmware can be updated using GENNECT Cross. Required: GENNECT Cross (Ver. 1.8 or later) Instrument firmware (Ver. 2.00 or later) |

Power-on Options

| | |
|--|--|
| <p>Canceling the power-saving function (p.30)</p> | <p>Turn on the instrument while holding down the LIGHT key.</p> |
| <p>Displaying the serial number</p> | <p>Turn on the instrument while holding down the RELEASE key. The serial number will be displayed three digits at a time. In the following example, the month and year of manufacture are May 2021. Example: [210] → [512] → [345] After checking the number, set the rotary switch to OFF.</p> |
| <p>Checking the HID setting (p.56)</p> | <ol style="list-style-type: none"> 1. Turn on the instrument while holding down the RELEASE key. The serial number screen will be displayed. 2. Press RELEASE key for 3 s or more. The HID setting saved by the Z3210 will be displayed. |
| <p>Displaying the software version</p> | <ol style="list-style-type: none"> 1. Turn on the instrument while holding down the 0 Ω ADJ key and the COMP key. 2. Press the RELEASE key while the [vEr] display is active. The display will alternate between the version number [vx.xx] and model [405x]. After checking the number, set the rotary switch to OFF. |

WARNING



Touching any of the high-voltage points inside the instrument is very dangerous. Customers are not allowed to modify, disassemble, or repair the instrument. Doing so may cause fire, electric shock, or injury.

Calibrations

The calibration period varies with the conditions and environment of use. It is recommended to determine a calibration period based on those factors and to have the instrument regularly calibrated by Hioki. Please contact your authorized Hioki distributor or reseller to have your instrument periodically calibrated.

Precautions when transporting the instrument

When transporting the instrument, be sure to observe the following precautions:

- To avoid damage to the instrument, remove the batteries from the instrument. Moreover, be sure to pack in a double carton. Damage that occurs during transportation is not covered by the warranty.
- When sending the instrument for repair, be sure to include details of the problem.

Disposal

Handle and dispose of the instrument in accordance with local regulations.

Cleaning

- To clean the instrument, wipe it gently with a soft cloth moistened with water or mild detergent.
- Wipe the display gently with a soft, dry cloth.
- Wipe the dust from metal parts of alligator clips with a soft cloth to avoid any impact on the measurements.

5.1 Troubleshooting

Before Returning for Repair

If damage is suspected, check the following before contacting your authorized Hioki distributor or reseller.

| Symptom | Check Items | Remedy and Reference |
|--|--|--|
| The power is not turning on. | Does the battery have sufficient charge? | Replace with the new batteries. (p.22) |
| | Have the batteries been installed improperly? | Install the batteries in the proper orientation.(p.22) |
| The batteries run out immediately. | Are you using alkaline batteries? | Replace the batteries with alkaline batteries.(p.22) |
| The MEASURE key is not working for the lead with a switch. | Is the plug of the lead with a switch fully inserted? | Fully insert the plug to the limit without any gaps. (p.25) |
| During insulation resistance, low resistance, or PVΩ measurement, the live circuit indicator and the display blinks in red, and the buzzer sounds. | Does the voltage applied between the measurement terminals exceed the following values? Insulation resistance, PVΩ: approx. 20 V Low resistance: approx. 5 V | Make sure that the measuring object is disconnected from a live circuit. If voltage exists in the measuring object, the live circuit indicator blinks. |

| Symptom | Check Items | Remedy and Reference |
|--|---|---|
| Unable to perform measurement. | Are you setting the rotary switch while the MEASURE key turned on? | Turn off the MEASURE key and then press it again. |
| | Is the voltage between the measuring terminals over any of the following values before turning on the MEASURE key? 50 V to 250 V range: Approx. 90 V 500 V and PVΩ 500 V ranges: Approx. 500 V 1000 V and PVΩ 1000 V ranges: Approx. 1000 V | Separate the measuring object from all sources of power before performing measurement. |
| Unable to perform measurement in 500 V, 1000 V or PVΩ range. | Is the instrument locked so as to prevent inadvertent voltage application? | Release the lock function. (p. 35) |
| In the 500 V range, 1000 V range or PVΩ range, turning on the MEASURE key enables the lock function that has been released. | Is the battery new? Does the battery have sufficient charge? Is alkaline battery used? | Replace the batteries with new alkaline batteries. *1 (p. 22) |
| | Is the temperature low (0°C or less)? | Remove the batteries and warm them up, or replace them with new alkaline batteries. (p. 22) |
| | Has 1 minute lapsed after the last operation? | Release the lock function again. (p. 35) |
| The measured value is shown as the maximum display value. | Is there a broken connection in a test lead? | Check the continuity of the test lead with a tester. |
| | Are the test leads securely connected? | Check the connection between the test leads and the instrument, and check the connection of the tips of the test leads. |

| Symptom | Check Items | Remedy and Reference |
|---|--|---|
| Measured values vary and fail to stabilize. | Is a charging circuit located near the measurement object? | Disconnect the circuit breaker for any nearby charging circuits. If this is not possible, use the lowest measured value as the measurement result. |
| Measured values acquired through insulation resistance measurement or PV Ω measurement fluctuate over time. (If using the IR4057-50, use the 1-minute value display function.) | When the measuring object connected is a capacitor: Does the measuring object have a large capacitance component (capacitor)? | If it is possible to remove the capacitor, do so. If not, use the lowest measured value as the measurement result. |
| | When the measuring object connected is not a capacitor: This phenomenon reflects the influence of the measuring object capacitance component. This is not a malfunction or error. | Select measured values acquired one minute after the start of the measurement. If a large capacitance component included in the measuring object causes the fluctuation of measured values, select measured values after they have stabilized. |

| Symptom | Check Items | Remedy and Reference |
|---|---|---|
| A different measured value results each time the same measuring object is measured. | Is there any impact due to the material of the measuring object? | Allow an adequate amount of time (about 1 hour to 1 day) to pass after the first measurement before repeating measurement. The effects of polarization* ² increase as the insulation resistance increases. |
| | Is there any impact due to the temperature/humidity characteristics of the measuring object? | Measure the object under the same temperature and humidity conditions. In general, an insulator's insulation resistance value will decrease as temperature and humidity increase. Reference: the insulation resistance value of some insulated cables decreases to 1/4 or less when the temperature increases 10°C. |
| The output voltage polarity is reversed. | The reversal is due to the characteristics of the insulation ohmmeter. This does not represent a malfunction. | — |

| Symptom | Check Items | Remedy and Reference |
|---|---|---|
| When the instrument is calibrated, the accuracy of the insulation resistance range falls outside the device specifications. | Has the supplied or optional test lead used? | Use the test leads that came with the instrument or its optional test leads to perform the calibration procedure. With standard wiring, characteristics are affected when the resistance in the 1000 V range reaches or exceeds 100 MΩ. |
| | Has the insulation of the test lead deteriorated? | Replace the deteriorated test lead with a new one. |

- *1 Batteries with high internal resistance may not be able to deliver enough energy to power the instrument, even if you're using new alkaline batteries or batteries with sufficient charge. If the instrument does not operate even though its batteries have just been replaced, try batteries from a different manufacturer.
- *2 Polarity: A phenomenon whereby a substance's positive and negative electric charges move in opposite directions when an electric field is applied to it, causing the center position of the positive and negative charges to shift.

Errors and status codes

When an error is displayed on the LCD screen, repair is necessary. Please contact your authorized Hioki distributor or reseller.

IR4053, IR4055, IR4056

| Code | Description | Remedy and Reference |
|---------------|--|--|
| Err1 | The instrument was unable to perform zero adjustment. (Low resistance measurement) | <ul style="list-style-type: none"> Verify that there is no broken connection in the test leads. Zero adjustment can be performed for readings of up to 3 Ω. Ensure that the wiring resistance is 3 Ω or less. (p.42) |
| | The specified fuse has not been installed. | Use only the specified type of fuse. (p.22) |
| Err2 | Settings data damaged. | Repair is required. |
| Err3 | Adjustment data damaged. | |
| Err4 | Abnormality in measurement circuit. | Replace the batteries. If there is no apparent improvement, the instrument needs repair. |
| Err6 | Abnormality in voltage generation circuit. | |
| Err8 | Wireless communications error. | Repair is required. |
| FUSE (blinks) | The protective fuse has tripped. | Replace the indicated fuse. (p.22) |
| bAtt | Low battery voltage. | Replace the batteries. (p.22) |

IR4057-50

| Code | Description | Remedy and Reference |
|---------------|---|---|
| Err 0ΩADJ | Zero adjustment is outside the allowable range. (Low resistance measurement) | <ul style="list-style-type: none"> • Verify that there is no broken connection in the test leads. • Zero adjustment can be performed for readings of up to 3 Ω. Ensure that the wiring resistance is 3 Ω or less. (p.42) |
| Err1 | Program data corrupt. | Repair is required. |
| Err2 | Adjustment data damaged. | |
| Err4 | The EEPROM used to store settings data has failed (including failure to communicate with the EEPROM). | |
| Err5 01 | Abnormality in measurement circuit. | Replace the batteries. If there is no apparent improvement, the instrument needs repair |
| Err5 02 | Abnormality in voltage generation circuit. | |
| Err8 | Z3210 communications error (connection failure; Z3210 or hardware failure) | Take the following actions (p.27): <ul style="list-style-type: none"> • Reinstall the Z3210. • Install a different Z3210. If the error persists, you are experiencing a instrument failure. Contact your authorized Hioki distributor or reseller to organize repair. |
| Err9 | Firmware update error | Use GENNECT Cross to update the firmware again. (p.69) |
| FUSE (blinks) | The protective fuse has tripped. (The fuse is user-replaceable.) | Replace the indicated fuse. (p.22) |
| APS → P.oFF | Powered off by APS. | — |
| bAtt → P.oFF | Instrument powered off due to supply voltage drop | Replace the batteries. (p.22) |

Appendix

Appx. 1 Measurement Principles

1. Insulation resistance measurement

The measuring object's insulation resistance R_x is calculated by applying a voltage V to the object, measuring the leak current I that flows to the object as a result, and dividing the voltage V by the leak current I .

2. Low resistance measurement (IR4056, IR4057-50)

The measuring object's resistance R_x is calculated by applying a current I to the measuring object, measuring the voltage V that occurs between the measurement terminals as a result, and dividing the voltage V by the current I .

3. PV Ω measurement (IR4053, IR4055)

The resistance R_x is calculated using the equation (Applied voltage V) / (Leakage current I) by applying a voltage V to the measuring object, and then measuring the leakage current I flowing through the measuring object and applied voltage V . (Voltage and current generated from the measuring object are subtracted.)

Appx. 2 Operation Uncertainty

The operation uncertainty and the variations of measurement value for the respective influence quantity approved by EN/IEC61557 are as follows:

| Intrinsic uncertainty/ influence quantity | | Operation range | Variation | |
|--|--------------------------|------------------------|---------------------------------------|----------------|
| | | | Insulation resistance | Low resistance |
| A | Intrinsic uncertainty | Reference condition | ±5% rdg | ±3% rdg ±2 dgt |
| E ₂ | Supply voltage | 4.5 V to 6.8 V | ±4% rdg | ±3% rdg ±2 dgt |
| E ₃ | Temperature | 0°C to 35°C | ±4% rdg | ±3% rdg ±2 dgt |
| B | Operation uncertainty | | ±12% rdg | ±30% rdg |
| Guaranteed range of operation uncertainty | | | 1st effective measurement range | 0.2 Ω to 2 Ω |

Influencing factor non-applicable for E₁ and E₄ to E₁₀

Appx. 3 Insulation Resistance Measurements for Solar Cell Array

There are two insulation resistance measurements for solar cell arrays. Characteristics of them are as follows:

Measurement with P-N opened

PV Ω measurement of this manual is explained with this measurement. As solar cell voltage influences the test voltage, the measurement may not be accurate. Incorrect procedure may damage the solar panel. If earth fault is occurred due to earth leakage as shown in the following figure, current being generated influences the insulation resistance meter resulting in inaccurate measurement with a normal insulation resistance meter. PV Ω measurement mode of the IR4053 and IR4055 allows accurate measurements without the effect from power generation.

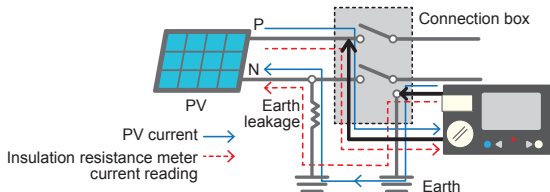

Measurement with P-N shorted

This measurement allows accurate measurements but is also a highly dangerous method as arc discharge may be generated due to the short circuit. There is also a fire risk depending on the deterioration level of the solar panel.

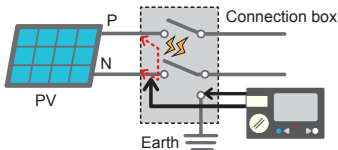

Warranty Certificate

HIKI

| | | |
|-------|---------------|--|
| Model | Serial number | Warranty period Three (3) years from date of purchase (___ / ___) |
|-------|---------------|--|

Customer name: _____

Customer address: _____

Important

- Please retain this warranty certificate. Duplicates cannot be reissued.
- Complete the certificate with the model number, serial number, and date of purchase, along with your name and address. The personal information you provide on this form will only be used to provide repair service and information about Hioki products and services.

This document certifies that the product has been inspected and verified to conform to Hioki's standards.

Please contact the place of purchase in the event of a malfunction and provide this document, in which case Hioki will repair or replace the product subject to the warranty terms described below.

Warranty terms

1. The product is guaranteed to operate properly during the warranty period (three [3] years from the date of purchase). If the date of purchase is unknown, the warranty period is defined as three (3) years from the date (month and year) of manufacture (as indicated by the first four digits of the serial number in YYYY format).
2. If the product came with an AC adapter, the adapter is warranted for one (1) year from the date of purchase.
3. The accuracy of measured values and other data generated by the product is guaranteed as described in the product specifications.
4. In the event that the product or AC adapter malfunctions during its respective warranty period due to a defect of workmanship or materials, Hioki will repair or replace the product or AC adapter free of charge.
5. The following malfunctions and issues are not covered by the warranty and as such are not subject to free repair or replacement:
 - 1. Malfunctions or damage of consumables, parts with a defined service life, etc.
 - 2. Malfunctions or damage of connectors, cables, etc.
 - 3. Malfunctions or damage caused by shipment, dropping, relocation, etc., after purchase of the product
 - 4. Malfunctions or damage caused by inappropriate handling that violates information found in the instruction manual on precautionary labeling on the product itself
 - 5. Malfunctions or damage caused by a failure to perform maintenance or inspections as required by law or recommended in the instruction manual
 - 6. Malfunctions or damage caused by fire, storms or flooding, earthquakes, lightning, power anomalies (involving voltage, frequency, etc.), war or unrest, contamination with radiation, or other acts of God
 - 7. Damage that is limited to the product's appearance (cosmetic blemishes, deformation of enclosure shape, fading of color, etc.)
 - 8. Other malfunctions or damage for which Hioki is not responsible
6. The warranty will be considered invalidated in the following circumstances, in which case Hioki will be unable to perform service such as repair or calibration:
 - 1. If the product has been repaired or modified by a company, entity, or individual other than Hioki
 - 2. If the product has been embedded in another piece of equipment for use in a special application (aerospace, nuclear power, medical use, vehicle control, etc.) without Hioki's having received prior notice
7. If you experience a loss caused by use of the product and Hioki determines that it is responsible for the underlying issue, Hioki will provide compensation in an amount not to exceed the purchase price, with the following exceptions:
 - 1. Secondary damage arising from damage to a measured device or component that was caused by use of the product
 - 2. Damage arising from measurement results provided by the product
 - 3. Damage to a device other than the product that was sustained when connecting the device to the product (including via network connections)
8. Hioki reserves the right to decline to perform repair, calibration, or other service for products for which a certain amount of time has passed since their manufacture, products whose parts have been discontinued, and products that cannot be repaired due to unforeseen circumstances.

HIKI E.E. CORPORATION

<http://www.hioki.com>

18-07 EN-3

HIOKI

<http://www.hioki.com>



**All regional
contact
information**

HEADQUARTERS

81 Koizumi
Ueda, Nagano 386-1192 Japan

HIOKI EUROPE GmbH

Rudolf-Diesel-Strasse 5
65760 Eschborn, Germany
hioki@hioki.eu

1906 EN

Edited and published by HIOKI E.E. CORPORATION

Printed in Japan

- CE declarations of conformity can be downloaded from our website.
- Contents subject to change without notice.
- This document contains copyrighted content.
- It is prohibited to copy, reproduce, or modify the content of this document without permission.
- Company names, product names, etc. mentioned in this document are trademarks or registered trademarks of their respective companies.